

3 1750 04479 7747

Cassette tape to MP3 converter

Model: EzCAP230

Thank you for choosing the cassette to MP3 converter. You have made an excellent decision. The following contents guide you how to use the product. Hope this device will bring you nice digital experience

Overview

With this Ezcap230 cassette tape to MP3 converter, you can easily convert your old tape to MP3 without a computer, you just need to plug a USB flash disc on then press "record" button, it has two mode to operate ---manually mode and auto mode, on auto mode will convert all of the music on tape to your USB disc in MP3 format automatically, and will partition each song automatically. On manually mode, you can partition each song by press next button during recording. You can also playback on it, or just put USB Flash to other place (computer, portable speaker, or transfer to your mobile phone, iPod, etc.) to play the recorded music.

Features

- ▶ Automatically or manually partition songs.
- ▶ Stand alone, no computer required.
- ▶ Plug & play.
- ▶ With Playback can check the recorded music on the device.
- ▶ Small size, can play, convert anywhere.

Specification

Converter format	MP3
Power supply	2*AA Battery, any USB port power supply (5V DC adapter, USB from computer, etc)

Format of USB flash	Support FAT,FAT32,exFAT
Working time	1 hour with 2*AA battery
Audio channel	Stereo L/R
Bit Rate	128Kbps
Dimensions	16*9.4*3.5cm
Weight	145g (without batteries)

Package Contents

- Main unit (EzCap230 cassette tape to mp3 converter)
- USB cable
- Earphone (optional)
- User Manual

Operate Instructions

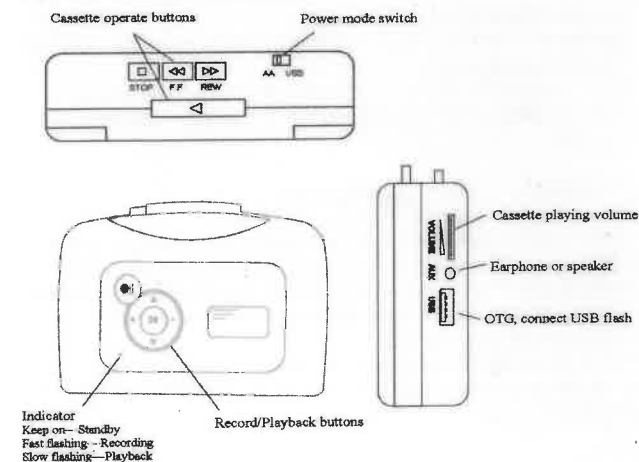

Chart 1 ---- Device

1, Get power supply:

There are two ways to get power supplied for the device: Use 2*AA batteries or from any USB port power supply (5V DC adapter, USB from computer, etc), by an USB cable (come with device in package) as below, if the DC adapter doesn't come with, you can use any USB port 5V DC adapter in your hand, 500mA to 1000mA is ok

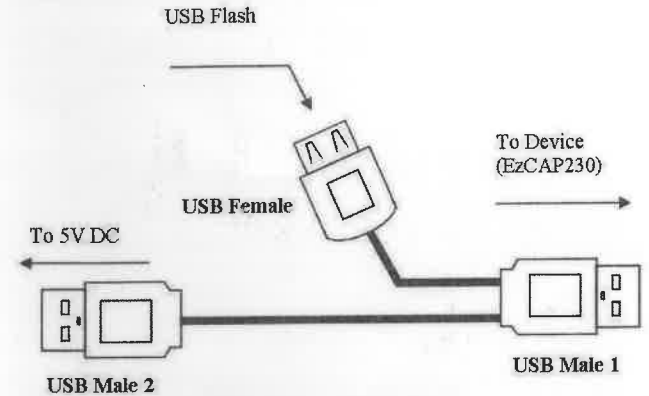

Chart 2 ----USB cable

There is an AA/USB switch on the top of the device, please switch it in right place according the way of power supply. (E.g. switch to AA if you use 2*AA batteries, or switch to USB if by DC adapter)

Note: We do not suggest use AA battery and DC adapter at same time, even we already make a protect design to avoid the DC adapter charge the normal AA battery when they are connecting same time. We still hope you just use only one way power supply, for safety.

There are two wrong ways of power supply:

- (1) Use AA battery, but switch to "USB", in this way, both cassette and recording/playback won't work, please switch to "AA" to get working.
- (2) Use DC adapter, but switch to "AA", in this way, the cassette won't work, but the recording/playback can work, and the indicator will be keeping on. Please switch to "USB" mode if you want the device get to work.

Once power supply ok, you will see the green indicator is keep on.

2, Put a cassette tape in device

Open the tape lid from the top of device, and put a tape in, then close the lid.

3, Plug an USB flash

Use an USB flash which has enough storage space (about 1MB for 1 minute music recording) plug into the device. Plug directly to USB port of the device if use AA batteries. Plug to the female port of USB cable (see chart 2) if power supply by DC adapter

You can also use USB card reader or USB hard drive as storage (Note: some card reader or USB HDD drive may cause problem when using)

4, Operate the cassette

You can use an earphone or a speaker plug to the "AUX" to listen music when playing or recording music. There are 4 buttons on the top of device:

Press to play	Press to stop	fast forward	rewind

Chart 3 ---buttons

Once you press the play button, the cassette player start to work, you can see the wheel running through the small window, you can set the volume

to a level you like by use rotary switch  , you may hear the playing music now (Note: this volume is also control the input level of recording, it means if you switch the level to "0" the level of recorded MP3 also be "0" then), then let's start next step --- recording (converting).

5, Recording

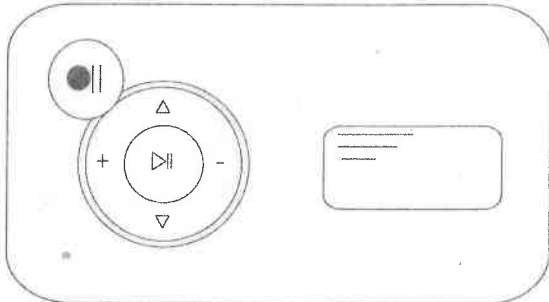



Charter 4 --- Recording panel

5.1 Recording in manually mode:

When the cassette playing and an USB flash is connecting, and the device is under standby mode (indicator keep on ) , and the color of indicator is green shows it at default manually mode. Just simply press the

recording button  then the device will start to recording (converting) the playing music to MP3 format, the green indicator will be quick flashing (if not, means not recording, re-plug your USB flash and try again) . Press the recording button again to stop recording and save a MP3 file in USB flash.

At the interval between two songs where you want to save in another file, short press  button, the flashing green indicator will be off about 2 seconds, then quick flash again to save in another file.

If you want do it at auto mode, simple at standby mode long press  button 3~5 seconds, till you see the indicator from green to blue.

5.2 Recording in auto mode:

On auto mode, ezcacp230 will detect each interval between two songs, and will save them in two files. So normally, if you have 6 songs at side A(or B) of your cassette, just put cassette in and play, then press record button, after 6 songs played, will automatic save **7 mp3 files** in your USB flash.(There will be **7 files for a 6 songs tape, the FV0001~FV0006 will be the effective MP3 files for 6 songs, the last one FV0007 is an empty one due to the short space between the end of 6th song to the end of whole tape.**)

Device will create a new folder name "TAPEMP3" in your USB disk, and save each MP3 name "FV0001 to FV9999"

If you want to switch back to manual mode from auto mode, stop recording(or playback) to standby mode (blue indicator keeps on), long press  button 3~5 seconds, till you see the indicator from blue to green, or simply power off ezcacp230, then power on again, it will load at default---manually mode .

5.3 Use AUX port, you can also record music from other sources with an 3.5mm audio cable (such as: radio, MD players, anything with audio line out)

5.4 Known problems in Auto mode:

Due to the auto function is based detecting the level of music: when the level is lower than the setting in firmware, ezcacp230 will take it as space between two songs, so there will be chance to meet following situations:
1, If there is a long pause in a song, ezcacp230 may take it as two songs, and save 2 files for it.

2, If the space between two songs is too short which ezcacp230 can not detect, ezcacp230 will take them as one song, and save the two songs in one file.

When you meet this situation, you can use the Audacity software to editing them.(find the link following)

Note: We do not suggest to power off (unplug the power supply) or unplug the USB flash during recording, even we make a design that the device will automatically save the MP3 file for previously recording when power off or USB flash unplugged during recording.

You have to repower (unplug AA battery or USB power supply, then re-plug) the device if you unplug the USB flash during recording, otherwise both recording and replay button will be un-working.

If you want to edit your recorded MP3 files, you can use a free software --- Audacity, download from: <http://audacity.sourceforge.net>

6, Playback

The device with playback function so you can easily checking the recorded file.

Note: You may feel the music volume level of playback is smaller than cassette playing, don't worry it, as the actual level of recording MP3 is normal, we just set a little down the playback level for save energy. You will find it is good when you playback the MP3 of your computer or mobile multimedia device (like iPod, mobile phone)

At standby mode, press playback button  , device will start to play the recording music, the indicator will be slow flashing. Press playback button again, will stop playback and back to standby mode. During playback, use

up/down button  to choose play previous or next file. Use **+/-** button to set volume up and down.

You can also copy other MP3 file to USB flash and plug to our device to replay it, but only files in "TAPEMP3" folder can be played.

Q&A

Q1, Press recording button, nothing happens, indicator keep on.

A: There are 3 possibilities for this problem:

- 1, USB flash connection problem----**solution:** just re-plug and try again
- 2, USB cable wrong connection, see chart 2, if plug USB male 1 to DC adapter, USB male 2 to device, this is wrong but you will see indicator keep on seems working, but device can not detect USB flash in this way, so can not recording----**solution:** connect USB in right way.
- 3, USB flash un-working ---**solution:** change one or fix your USB flash

Q2, The indicator in on, but press play button the cassette doesn't running:

A: There are 2 possibilities:

- 1, Batteries no much power exist----**solution:** change new batteries or use DC adapter to power supply.
- 2, Wrong operation, if use USB DC adapter to supply power, but the AA/USB switch is on "AA" side, will cause this problem----**solution:** switch to right place.

Q3, Press Playback button, no music playing.

A: There are 2 possibilities:

- 1, If the indicator is slow flashing, means device is playing the music, but you can't hear anything, maybe because the volume level is too low, please try to use "+" to increase volume, if still no lucky, maybe because the source volume is too low when recording, you need record it again after increase volume.
- 2, If the indicator is keep on, means not playing. You need press playback button again as sometimes you may pressed, but the soft touch button hasn't been touched.